

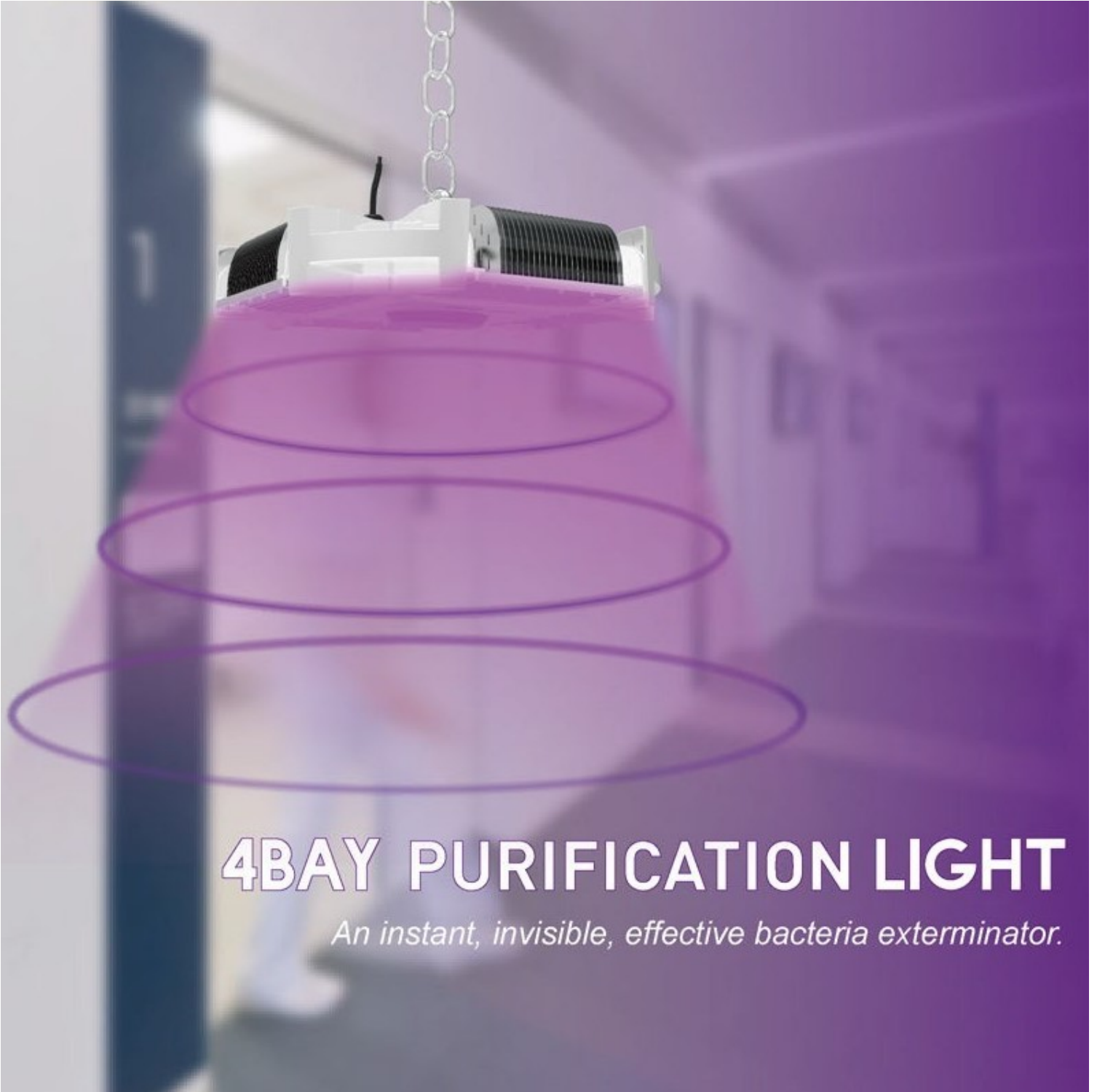

General Swiss Energy

4BAY PURIFICATION LIGHT

An instant, invisible, effective bacteria exterminator.

Parameters

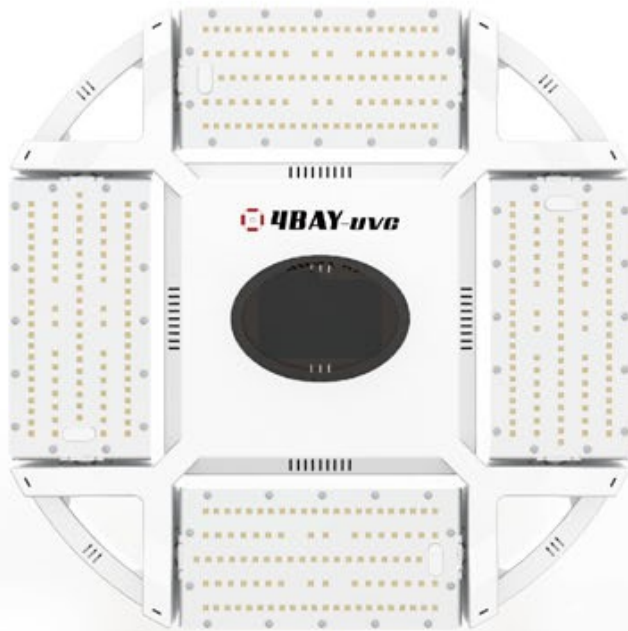

WATTAGE	50/100/150/200W
DRIVER	MEANWELL
RATED VOLTAGE	AC 100-240V 277V~, 50/60Hz
POWER FACTOR	>0.95
HEAT SINK	ALUMINIUM COOLING FIN
OPERATING TEMP	-40℃~40℃
SIZE	429x429x159 mm

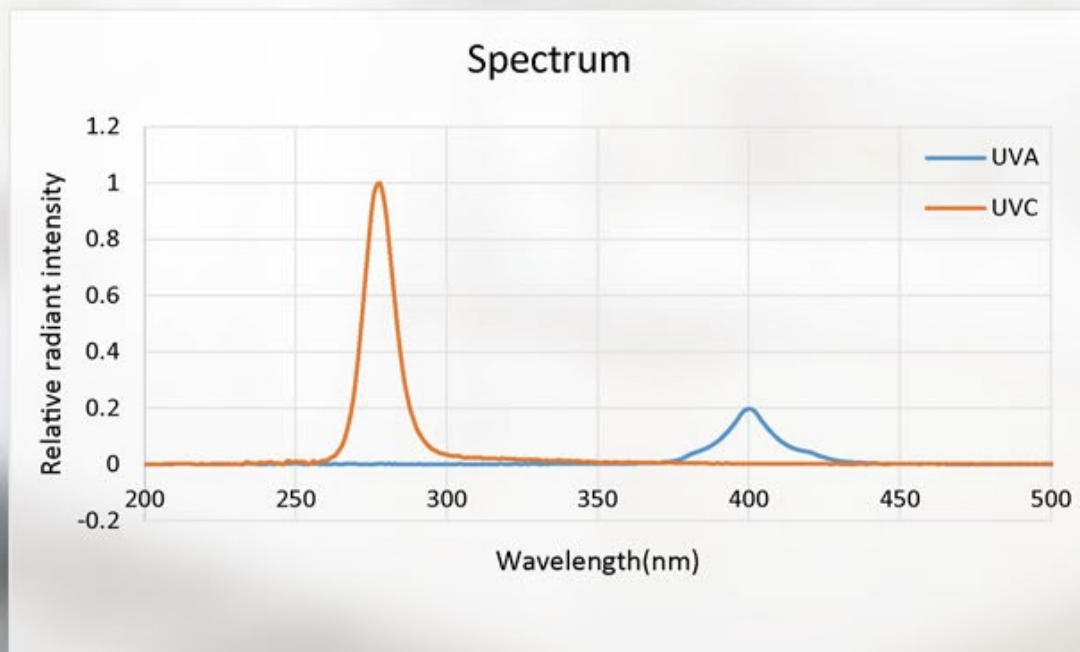

UVC Three-dimensional light field simulation

Size:1000x1000x600cm

Time: 30min

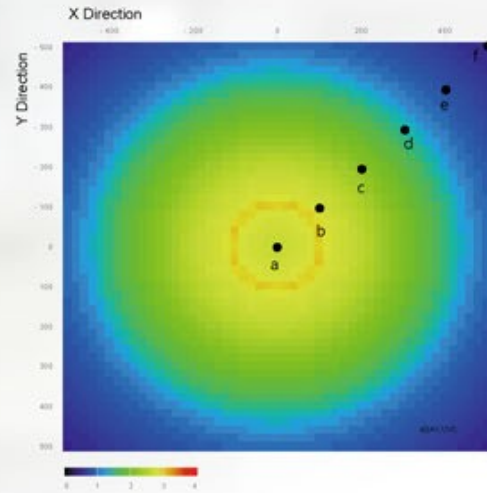
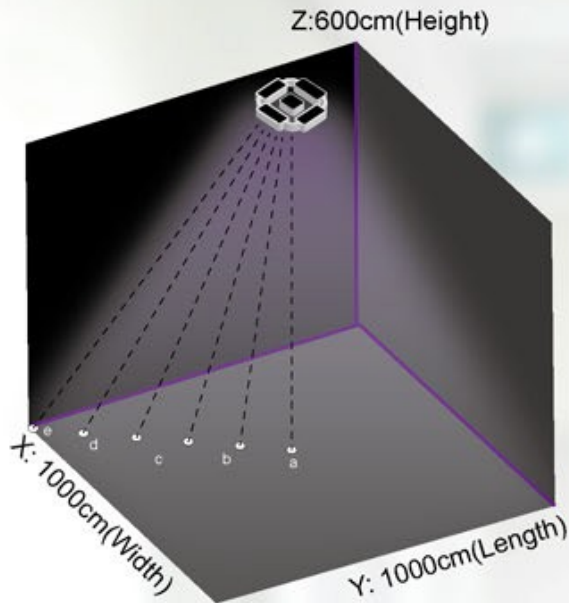

	Position(X,Y)	Sterilization rate
a	0, 0	92.0567%
b	100, -100	93.6904%
c	200, -200	87.4107%
d	300 -300	74.8811%
e	400, -400	60.1893%
f	500, -500	36.9043%

Time: 60min

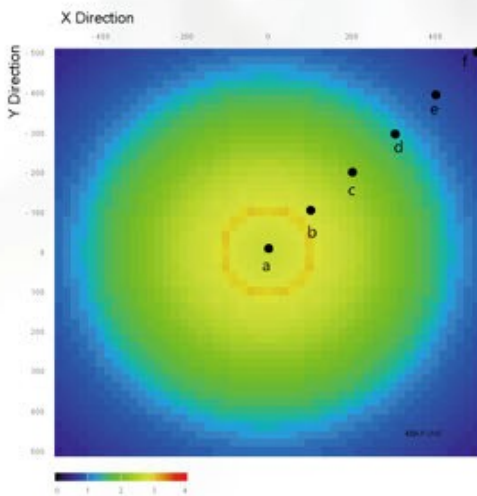

	Position(X,Y)	Sterilization rate
a	0, 0	99.4988%
b	100, -100	99.6019%
c	200, -200	98.7411%
d	300 -300	93.6904%
e	400, -400	80.0474%
f	500, -500	60.1893%

Time: 120min

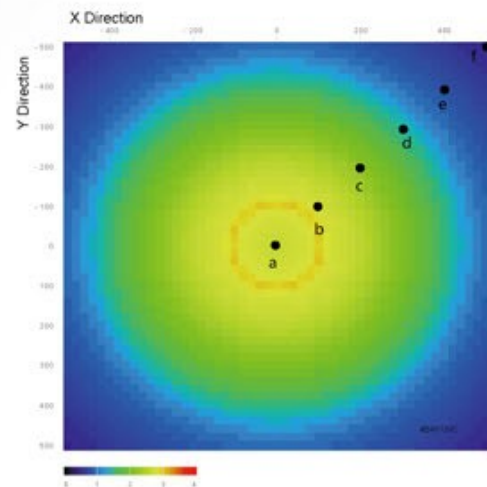

	Position(X,Y)	Sterilization rate
a	0, 0	99.9975%
b	100, -100	99.9984%
c	200, -200	99.9842%
d	300 -300	99.6019%
e	400, -400	96.0189%
f	500, -500	84.1511%

UVC Three-dimensional light field simulation

Size: 1200x1200x750cm

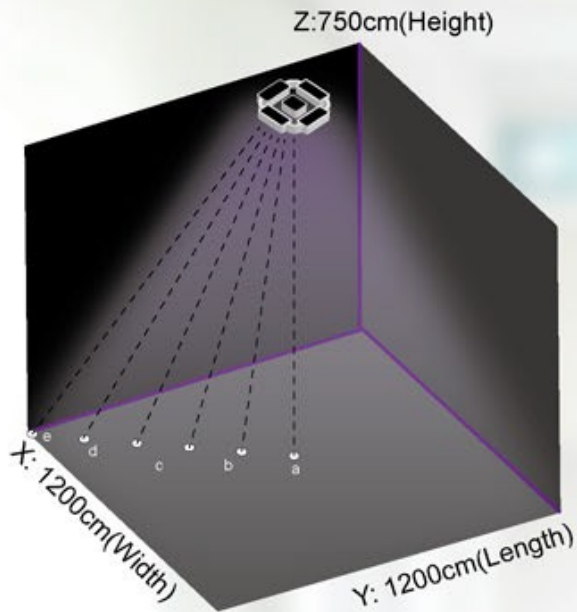

Time: 60min

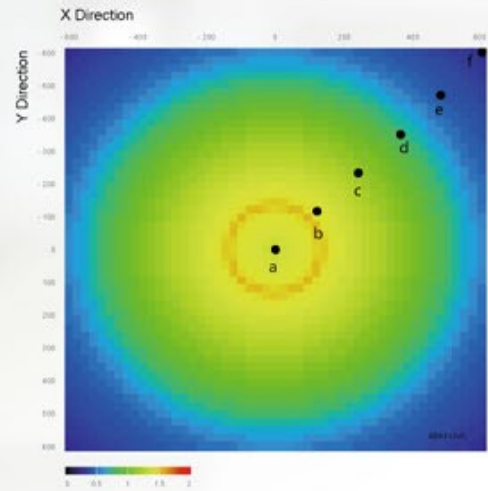

	Position(X,Y)	Sterilization rate
a	0, 0	96.8377%
b	120, -120	96.8377%
c	240, -240	94.9881%
d	360, -360	84.1511%
e	480, -480	68.3772%
f	600, -600	49.8813%

Time: 120min

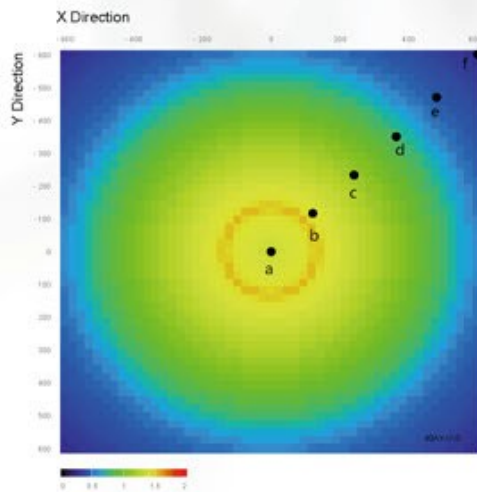

	Position(X,Y)	Sterilization rate
a	0, 0	99.8741%
b	120, -120	99.9206%
c	240, -240	99.6838%
d	360, -360	98.0047%
e	480, -480	90.0000%
f	600, -600	74.8811%

Time: 180min

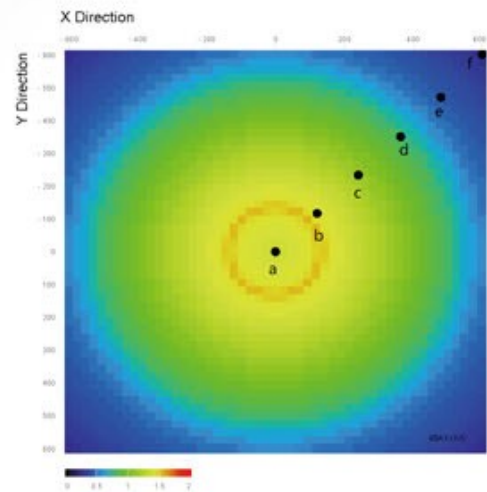

	Position(X,Y)	Sterilization rate
a	0, 0	99.9960%
b	120, -120	99.9975%
c	240, -240	99.9842%
d	360, -360	99.6838%
e	480, -480	96.0189%
f	600, -600	87.4107%

Ultraviolet C

'The Truly Effective Purification Wavelength'



200-280nm. The non visible precision UVC chip used in this product.



390-400nm. The purple visible UVA chip used in imitation pseudo products with no purification properties.

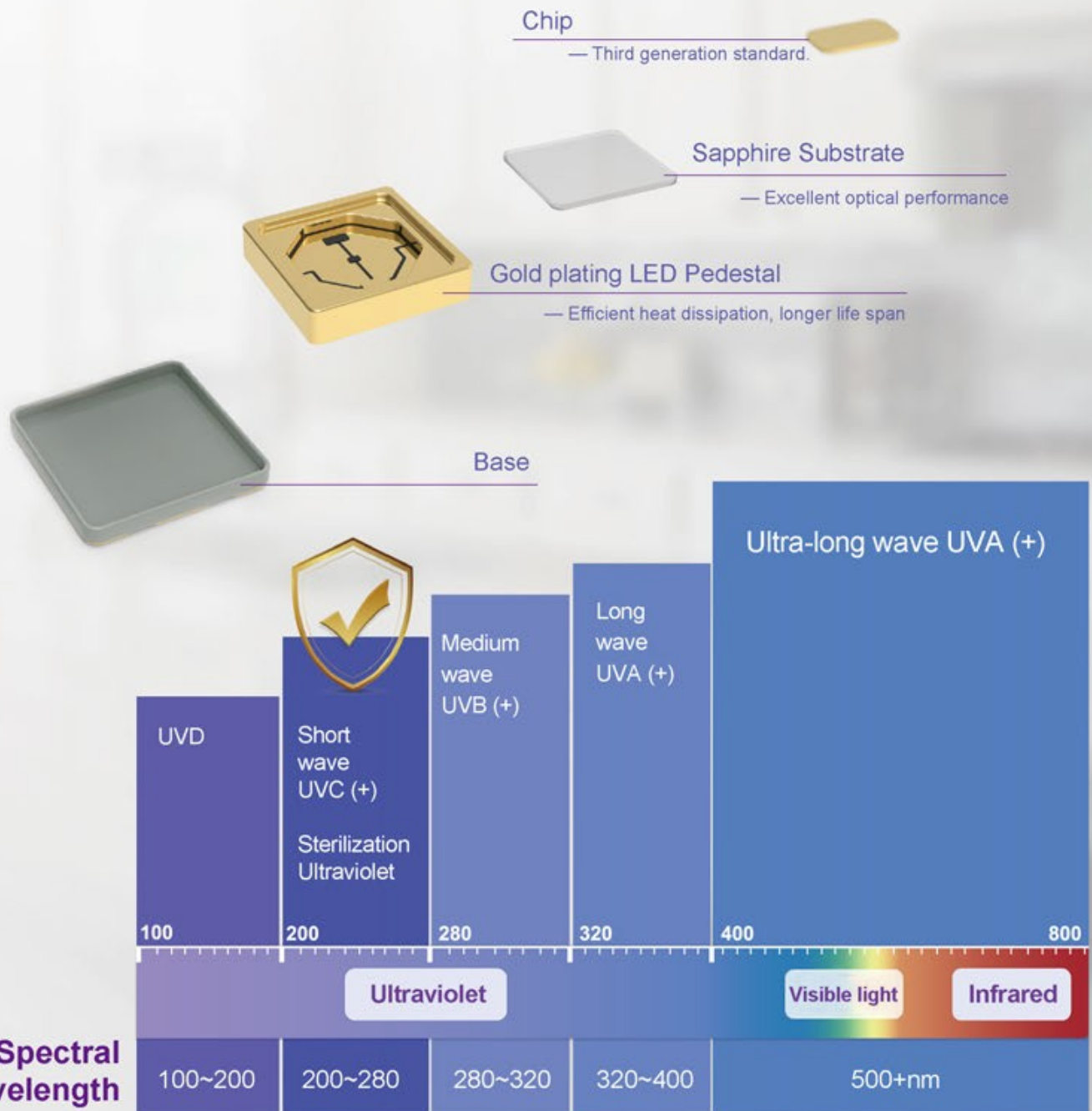

UV Tube

High Ozone concentrations as well as the leaked Mercury extremely harmful for human

UVC

UVC true ultraviolet short wave sterilization, no ozone, no mercury.

UVA and UVB

The lower spectrum wavelength of regular UV light. Not adequate or capable for bacilli eradication.

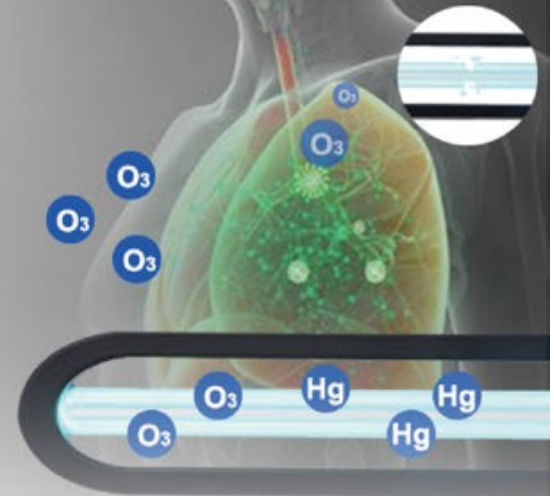

HOW UVC WORKS?

Ultra-Violet (UV) light is invisible to human eyes. It can be subdivided into three categories: UVA, UVB and UVC. UV-A from 320 to 400 nm UV-B from 280 to 320 nm UV-C from 200 to 280 nm.

UVC radiation is known to break the DNA of bacteria, viruses and spores. As a result, they are rendered harmless.

UV radiation can be used for multiple purposes in water and air treatment, but is primarily employed as a disinfection process that inactivates micro-organisms without chemicals. For other applications, UV is used for the removal of organic and inorganic chemicals, including chlorine, chloramines, ozone and Total Organic Carbon (TOC) emerging contaminants.

UVC radiation has been proven to be effective against waterborne pathogenic microorganisms including those responsible for cholera, hepatitis, polio, typhoid, giardia, cryptosporidium and many other bacterial, viral and parasitic diseases.

UVC disinfection is complementary to Chlorine disinfection: it deactivates organisms that are resistant to Chlorine such as giardia and cryptosporidium.

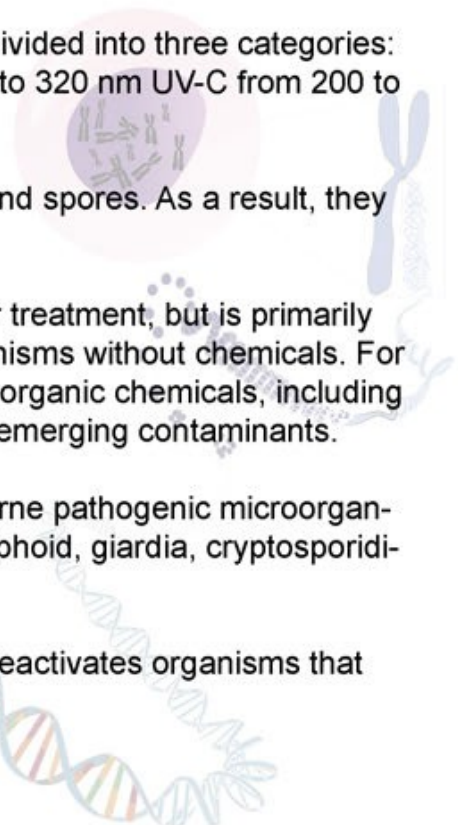

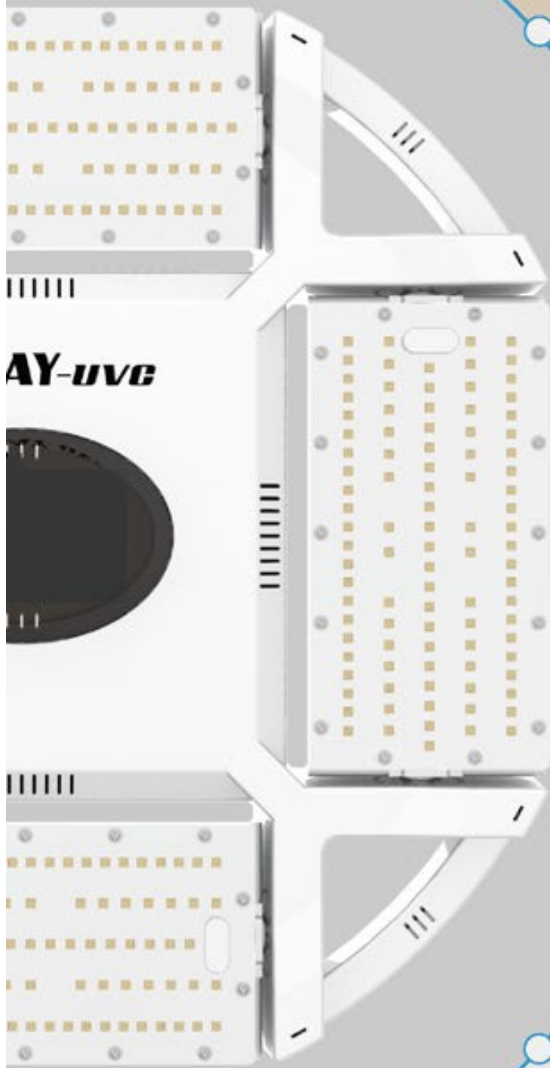

Minimal additional spend with lower operational costs than regular gas fluorescent lighting



8 times UVC output & 5 times life span than UV tube



Alarm device protects workforce from any harmful UVC radiation dosage



Same installation with high bay light, easy to operate and maintain



No Mercury & Ozone emissions during operation together with no 'end of life' disposal issues



Keep the operation area under lights clean from pathogenic bacteria



Silent potent disinfection providing assured peace of mind

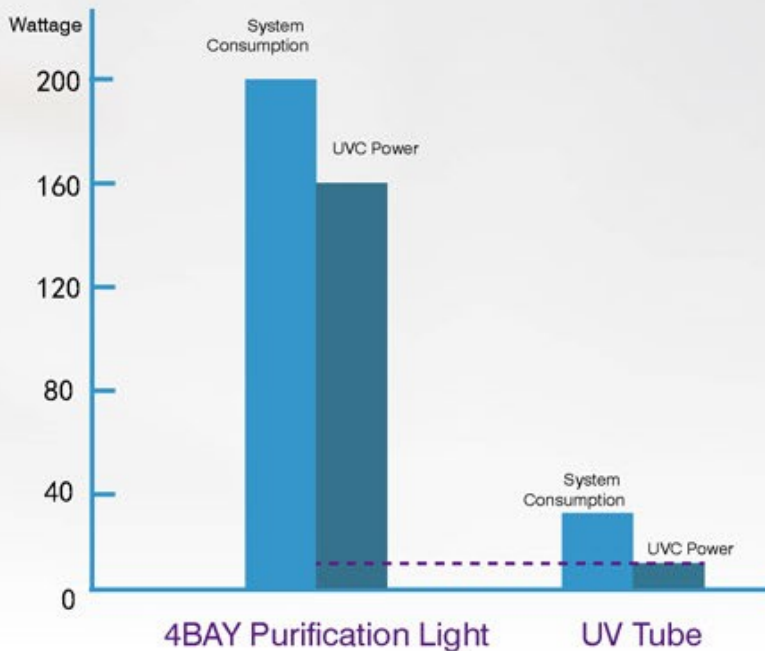

"A 4Bay purification light is equivalent to 30pcs conventional UV tube."



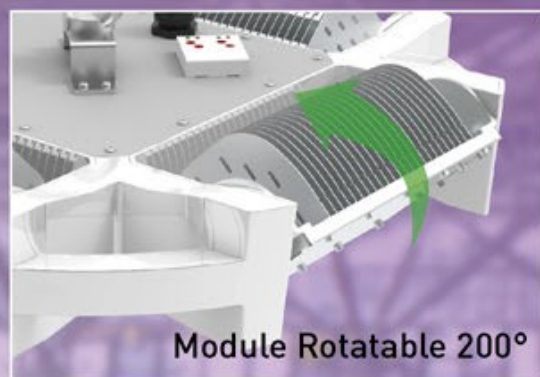
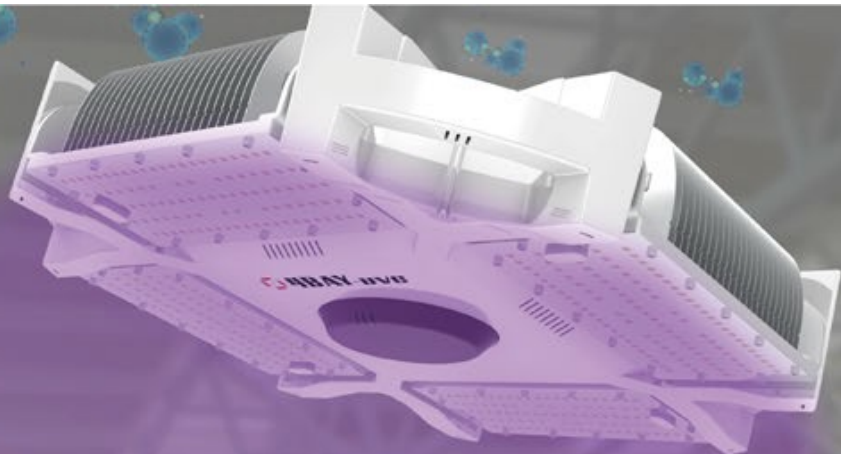

Silent Guardian

Highly efficient non-chlorinated bactericidal, no chemical drugs residue

Application



Warehouse



Stadium



Hospital



Factory



Supermarket



Station



Airport



Laundry

Manual Control

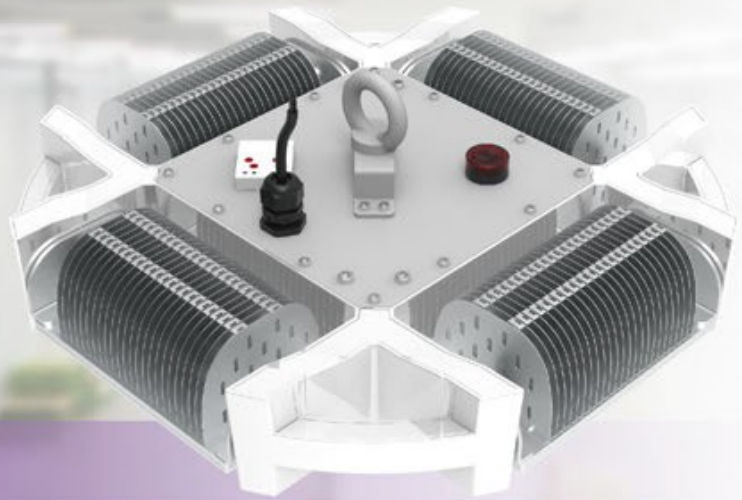

Work pattern

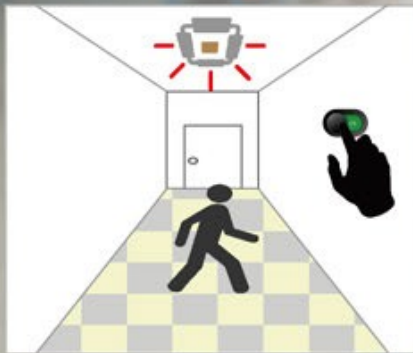

1. Switch the light on, start with 10 seconds alarm, please leave immediately!

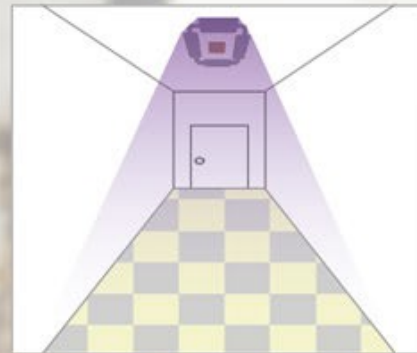

2. The purification light start working, and automatically turned off after 2 hours (optional).

Setting purification time

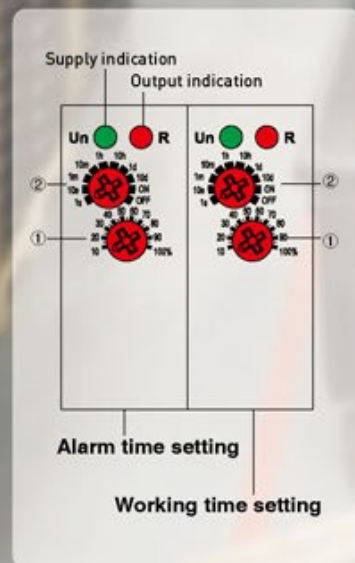
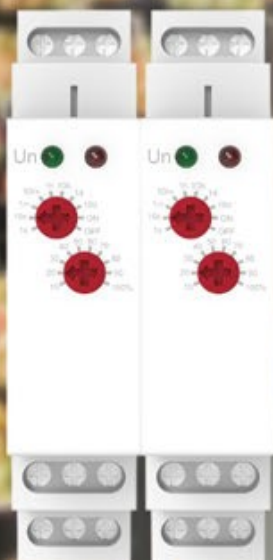

Please rotate ② to set timing, and rotate ① to set the timing percentage.

For example: set the time to 2 hours, please rotate ② to "10h" and ① to 20%.

Packaging and Size

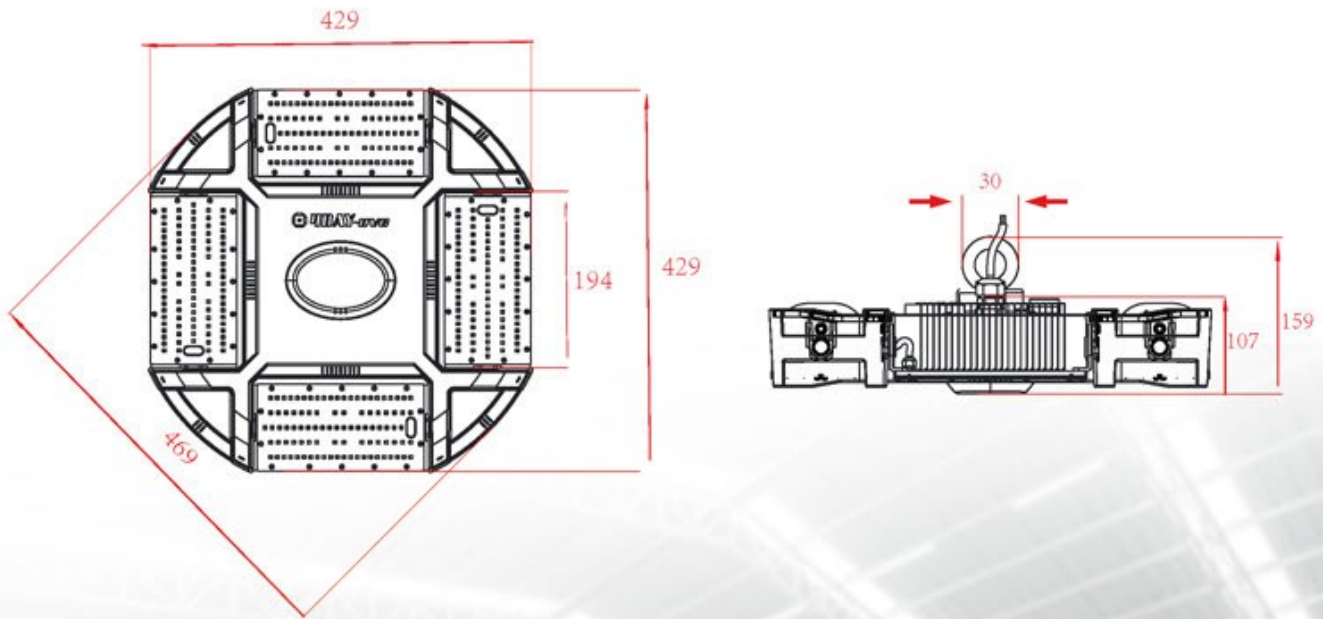

Model	Net Weight	Size of Box	Weight of Carton	Size of Carton	Gross Weight of Carton	PCS /Carton
50W	5.30kg±5%	47*46*15cm	6.10kg±5%	50*49*66cm	26.50KG±5%	4
100W	5.35kg±5%	47*46*15cm	6.15kg±5%	50*49*66cm	26.66KG±5%	4
150W	5.45kg±5%	47*46*15cm	6.25kg±5%	50*49*66cm	26.65KG±5%	4
200W	5.70kg±5%	47*46*15cm	6.50kg±5%	50*49*66cm	26.90KG±5%	4